

WARNING & EMERGENCY

STROBE LIGHTS

Pages 260-273

LED

SERIES	COMMON SIZE	PAGES
30® Series	2"	260
Super 44®	4"	260-263
Super 60®	2" x 6"	264-266
4 Diode 1"	1"	267
16 Diode Self-Contained	3" x 5"	267
Surface Mount	Multiple	268-270
Grommet Mount	Multiple	270

STROBE TUBE

SERIES	COMMON SIZE	PAGES
1in 1 Bulb	1"	270
2in x 5in 1 Bulb	2" x 5"	271
2in x 6in 1 Bulb	2" x 6"	271
3in x 5in 1 bulb	3" x 5"	271
4in 1 Bulb	4"	272
7in 1 Bulb	7"	272
Hide-A-Way Systems		273

BEACONS

Pages 274-280

LED

SERIES	PAGES
Class 1 High Profile	274
Class 1 Medium Profile	274-275
Class 1 Low Profile	275
Class 2 Low Profile	275-276

HALOGEN

SERIES	PAGES
Class 1	277
Class 2	277

GAS DISCHARGE

SERIES	PAGES
Class 1 High Profile	278
Class 1 Medium Profile	278-279
Class 1 Low Profile	279-280

LIGHT BARS

Pages 282-285

LED

SERIES	PAGES
Permanent Mount 4" x 36"	282
Permanent Mount 5" x 19"	282
Permanent Mount 5" x 47"	282

INCANDESCENT

SERIES	PAGES
5" x 46"	283

HALOGEN

SERIES	PAGES
4.5" x 16"	283
5" x 36"	284
5" x 46"	284
5" x 47"	284

GAS DISCHARGE

SERIES	PAGES
4.5" x 16"	285
5" x 36"	285

TRAFFIC CONTROL LIGHT BARS

Pages 286-287

SERIES	PAGES
LED	286

SERIES	PAGES
Halogen	287







Warning & Emergency

Developed through Truck-Lite's experience in both LED design and heavy-duty warning lighting systems, these strobes and beacons offer rugged and dependable conspicuity regardless of the application.

<p>Mount type</p>	<p>Flange, Grommet, Surface, Stud, 1-Screw, 2-Screw, 4-Screw, Bracket, Magnetic, Permanent</p>
<p>Shapes</p>	<p>Strobe Round, oval, rectangular</p> <p>Beacon Low profile, medium profile, high profile</p>
<p>Classifications</p> <p>Before selecting any warning or safety lighting, it's important to know the legal classifications for a given application.</p>	<p>Class I The brightest of all warning lighting, Class I lights most often appear on emergency vehicles, such as police cars, fire trucks and ambulances.</p> <p>Class II Class II warning lights produce no more than 25% of the intensity of Class I strobes and beacons. These usually appear on utility and construction vehicles.</p> <p>Class III Producing approximately 40% of the intensity of Class II strobes and beacons, Class III warning lights are typically used indoors, such as on a forklift.</p>

(800) 562-5012 | truck-lite.com

 <p>Manufacturing & Quality</p>	 <p>Testing & Safety</p>
<p>Truck-Lite's LED warning lighting is built using premium materials and backed by industry-leading warranties.</p> <p>Designed to last the life of your vehicle, Truck-Lite's solid-state construction and sealed circuitry mean that you can depend on your lights to withstand shock, vibration, moisture and debris.</p>	<p>All Truck-Lite warning and safety lighting is subjected to rigorous environmental, electrical and mechanical testing before they are validated and released to the market.</p>
 <p>Performance & Maintenance</p>	 <p>Customer Support</p>
<ul style="list-style-type: none"> • Lower energy consumption • Impact-resistant lenses and rugged housing protect against damage from even the toughest applications • Solid-state electronics designed for long-term dependability 	<div data-bbox="885 1228 957 1302"> </div> <p>Customer Service (800) 562-5012 customerservice@truck-lite.com</p> <div data-bbox="885 1449 957 1522"> </div> <p>Technical Support (888) 562-5012 tltech@truck-lite.com</p> <p>Warning & Emergency Warranties</p> <div data-bbox="869 1774 1420 1869"> </div>
<p>(800) 562-5012 truck-lite.com</p>	

LED

30 SERIES

30[®] SERIES, LED, 3 DIODE, SELF CONTAINED, GROMMET MOUNT

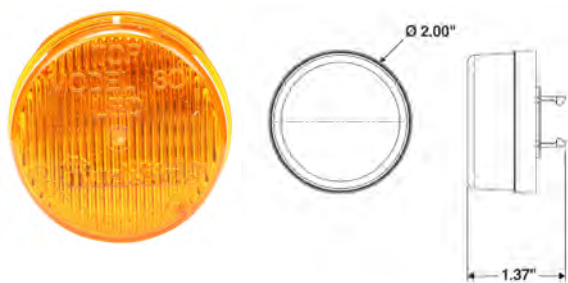

- External power pack not required.
- Features internal circuitry to create self-flashing lamp.
- Flashes when power supplied (80 FPM).
- Not for standard marker applications, for auxiliary/strobe use only.
- Uses Fit 'N Forget connector for added corrosion & moisture resistance.
- Utilized to warn operator of fault conditions.



Part Number	Lens Color	Lamp Connector	Plug Side 1	Plug Side 2	Volts	Amps
30286Y	Yellow	Fit 'N Forget M/C	No Plug	No Plug	12	0.06
30286R	Red	Fit 'N Forget M/C	No Plug	No Plug	12	0.06

LED

SUPER 44

SUPER 44[®], LED, 6 DIODE, SELF CONTAINED, GROMMET MOUNT

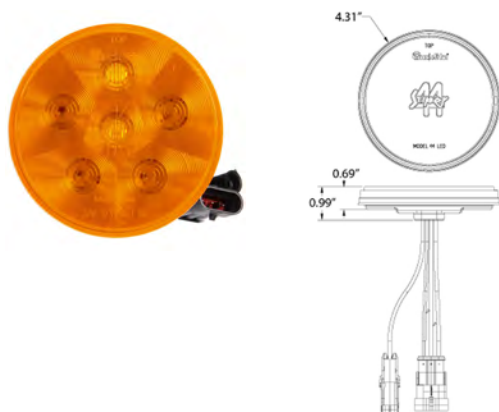

- New Super 44 Series Rear Turn Strobe lamp provides a quad flash pattern with solid-state LED technology
- Turn signal override feature momentarily overrides strobe function allowing lamps to signal for turn functions
- Lateral system allows alternating flash patterns without the need of a separate box, saving on cost and additional installation time
- Uses Truck-Lite 6-Diode round optics pattern to compliment S/T/T and B/U applications
- Fully encapsulated electronics and hard-wired design protect the lamp from corrosion and damage caused by chemicals and moisture
- New lamp design features a slim profile for mounting in areas of limited space
- Using 2 in-phase lamps or 2 out-phase lamps provide a synchronized flash, 1 in-phase lamp and 1 out-phase lamp provides alternating flash
- Features the Truck-Lite Limited Lifetime Warranty



Part Number	Lens Color	Lamp Connector	Plug Side 1	Plug Side 2	Volts	Amps	Mount Color	Warning Class	Phase
44217Y	Yellow	Hardwired	Hardwired	Packard Connector 282087/ Weather Connector 12015791	12	0.7	White	II	in-phase
44218Y	Yellow	Hardwired	Hardwired	Packard Connector 282087/ Weather Connector 12015791	12	0.7	White	II	out-phase
44110Y	Yellow	Hardwired	Hardwired	Packard Connector 282087/ Weather Connector 12015791	12	0.7	White	II	
44248Y	Yellow	Hardwired	Hardwired	Stripped End	12	0.7	White	II	in-phase
44249Y	Yellow	Hardwired	Hardwired	Stripped End	12	0.7	White	II	out-phase
44114Y	Yellow	Hardwired	Hardwired	Stripped End	12	0.7	White	II	

LED, 42 DIODE, 4", REMOTE, GROMMET MOUNT, KIT



- LED retrofit kit for front loader waste haulers
- Features 2 LED Model 60 front, park and turn lamps and 4 LED Super 44 turn signal lamps



Part Number	Position	Lens Color	Lamp Connector	Plug Side 1	Plug Side 2	Volts	Amps	Mount Color	Kit Includes
30286Y	Front	Yellow	Fit 'N Forget S.S.	Fit 'N Forget S.S.	Straight PL-3	12	0.54	Black	44201y, 60290y, 40700 grommet, 88824 plug
30286R	Rear	Yellow	Fit 'N Forget S.S.	Fit 'N Forget S.S.	Straight PL-3	12	0.54	Black	44201y, 40700 grommet, 88824 plug, 94706 plug

SUPER 44[®], LED, 42 DIODE, SELF CONTAINED, GROMMET MOUNT



- External power pack not required
- Metalized reflector version offers more intense focused light
- Non-metalized version offers wider viewing angle
- Dual or quad flashing patterns
- Meets recommended SAE J1318 and J845 photometric specifications
- Synchronized alternating feature
- Lamp life rated at 100,000 hours
- Resistance to shock and vibration
- Fit 'N Forget S.S. adapter plug provides corrosion and moisture resistance
- Integral flange option features built-in lens



Part Number	Lens Color	Lamp Connector	Plug Side 1	Plug Side 2	Volts	Amps
44211Y	Yellow	Fit 'N Forget S.S.	No Plug	No Plug	12	0.5

SUPER 44[®], LED, 42 DIODE, SELF CONTAINED, GROMMET MOUNT, KIT



- External power pack not required
- Metalized reflector version offers more intense focused light
- Non-metalized version offers wider viewing angle
- Dual or quad flashing patterns
- Meets recommended SAE J1318 and J845 photometric specifications
- Synchronized alternating feature
- Lamp life rated at 100,000 hours
- Resistance to shock and vibration
- Fit 'N Forget™ adapter plug provides corrosion and moisture resistance
- Integral flange option features built-in lens



Part Number	Lens Color	Lamp Connector	Plug Side 1	Plug Side 2	Volts	Amps	Mount Color
44211R	Red	Fit 'N Forget S.S.	Fit 'N Forget S.S.	Female PL-2	12	0.5	Black

SUPER 44®, LED, 42 DIODE, SELF CONTAINED, GROMMET MOUNT, METALIZED

LED

SUPER 44



- External power pack not required
- Metalized reflector version offers more intense focused light
- Non-metalized version offers wider viewing angle
- Dual or quad flashing patterns
- Meets recommended SAE J1318 and J845 photometric specifications
- Synchronized alternating feature
- Lamp life rated at 100,000 hours
- Resistance to shock and vibration
- Fit 'N Forget™ adapter plug provides corrosion and moisture resistance
- Integral flange option features built-in lens



Part Number	Lens Color	Lamp Connector	Plug Side 1	Plug Side 2	Volts	Amps
44212R	Red	Fit 'N Forget S.S.	No Plug	No Plug	12	0.5
44212Y	Yellow	Fit 'N Forget S.S.	No Plug	No Plug	12	0.5

SUPER 44®, LED, 42 DIODE, SELF-CONTAINED, GROMMET MOUNT, KIT

LED

SUPER 44

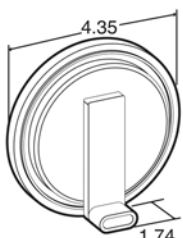

- External power pack not required
- Metalized reflector version offers more intense focused light
- Non-metalized version offers wider viewing angle
- Dual or quad flashing patterns
- Meets recommended SAE J1318 and J845 photometric specifications
- Synchronized alternating feature
- Lamp life rated at 100,000 hours
- Resistance to shock and vibration
- Fit 'N Forget™ adapter plug provides corrosion and moisture resistance
- Integral flange option features built-in lens



Part Number	Lens Color	Lamp Connector	Plug Side 1	Plug Side 2	Volts	Amps	Mount Color	Kit Includes
44101R	Red	Fit 'N Forget S.S.	Fit 'N Forget S.S.	Stripped End/Ring Terminal	12	0.5	Black	44211R, 40700 grommet, 95220 plug
44101Y	Yellow	Fit 'N Forget S.S.	Fit 'N Forget S.S.	Stripped End/Ring Terminal	12	0.5	Amber	44211Y, 40700 grommet, 95220 plug

SUPER 44®, LED, 42 DIODE, SELF-CONTAINED, METALIZED, GROMMET MOUNT, KIT

LED

SUPER 44



- External power pack not required
- Metalized reflector version offers more intense focused light
- Non-metalized version offers wider viewing angle
- Dual or quad flashing patterns
- Meets recommended SAE J1318 and J845 photometric specifications
- Synchronized alternating feature
- Lamp life rated at 100,000 hours
- Resistance to shock and vibration
- Fit 'N Forget™ adapter plug provides corrosion and moisture resistance
- Integral flange option features built-in lens



Part Number	Lens Color	Lamp Connector	Plug Side 1	Plug Side 2	Volts	Amps	Mount Color	Kit Includes
44102Y	Yellow	Fit 'N Forget S.S.	Fit 'N Forget S.S.	Stripped End/Ring Terminal	12	0.5	Black	44212Y, 40700 grommet, 95220 plug
44102R	Red	Fit 'N Forget S.S.	Fit 'N Forget S.S.	Stripped End/Ring Terminal	12	0.5	Black	44212R, 40700 grommet, 95220 plug

SUPER 44[®], LED, 42 DIODE, SELF CONTAINED, FLANGE MOUNT



- External power pack not required
- Metalized reflector version offers more intense focused light
- Non-metalized version offers wider viewing angle
- Dual or quad flashing patterns
- Meets recommended SAE J1318 and J845 photometric specifications
- Synchronized alternating feature
- Lamp life rated at 100,000 hours
- Resistance to shock and vibration
- Fit 'N Forget™ adapter plug provides corrosion and moisture resistance
- Integral flange option features built-in lens

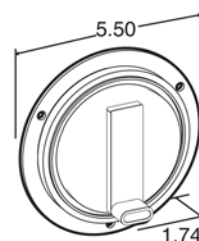

Part Number	Lens Color	Lamp Connector	Plug Side 1	Plug Side 2	Volts	Amps	Mount Color
44103R	Red	Fit 'N Forget S.S.	Fit 'N Forget S.S.	Stripped End/Ring Terminal	12	0.5	Red
44103Y	Yellow	Fit 'N Forget S.S.	Fit 'N Forget S.S.	Stripped End/Ring Terminal	12	0.5	Amber
44213R	Red	Fit 'N Forget S.S.	No Plug	No Plug	12	0.5	Black
44213Y	Yellow	Fit 'N Forget S.S.	No Plug	No Plug	12	0.5	Gray

SUPER 44[®], LED, 42 DIODE, SELF CONTAINED, METALIZED, FLANGE MOUNT



- External power pack not required
- Metalized reflector version offers more intense focused light
- Non-metalized version offers wider viewing angle
- Dual or quad flashing patterns
- Meets recommended SAE J1318 and J845 photometric specifications
- Synchronized alternating feature
- Lamp life rated at 100,000 hours
- Resistance to shock and vibration
- Fit 'N Forget™ adapter plug provides corrosion and moisture resistance
- Integral flange option features built-in lens

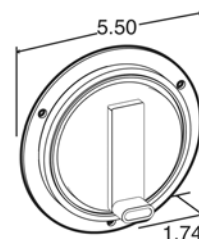

Part Number	Lens Color	Lamp Connector	Plug Side 1	Plug Side 2	Volts	Amps	Mount Color
44104R	Red	Fit 'N Forget S.S.	Fit 'N Forget S.S.	Stripped End/Ring Terminal	12	0.5	Gray
44104Y	Yellow	Fit 'N Forget S.S.	Fit 'N Forget S.S.	Stripped End/Ring Terminal	12	0.5	Gray
44214R	Red	Fit 'N Forget S.S.	No Plug	No Plug	12	0.5	Gray
44214Y	Yellow	Fit 'N Forget S.S.	No Plug	No Plug	12	0.5	Gray

SUPER 44[®], LED, 42 DIODE, SELF CONTAINED, 1 STUD MOUNT



- Durable synthetic rubber housing resists corrosion
- Includes mounting hardware
- Mounts on 5/16 - 18 stud
- External power pack or control module not required
- Meets SAE J1318 and J845 photometric specifications
- Synchronized alternating feature

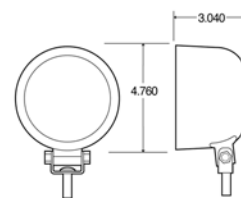

Part Number	Lens Color	Lamp Connector	Plug Side 1	Plug Side 2	Volts	Amps	Mount Color
44216R	Red	Fit 'N Forget S.S.	Fit 'N Forget S.S.	.180 Bullet/Ring Terminal	12	0.57	Black
44216Y	Yellow	Fit 'N Forget S.S.	Fit 'N Forget S.S.	.180 Bullet/Ring Terminal	12	0.57	Black

SUPER 60[®], LED, 36 DIODE, SELF CONTAINED, GROMMET MOUNT

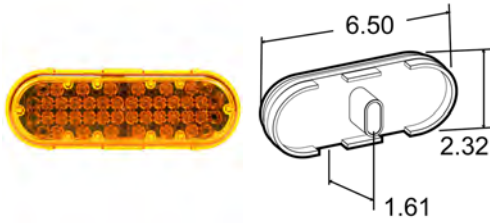

- External power pack not required
- Metalized reflector version offers more intense focused light
- Non-metalized version offers wider viewing angle
- Dual or quad flashing patterns
- Meets recommended SAE J1318 and J845 photometric specifications
- Mounts horizontally or vertically
- Lamp life rated at 100,000 hours
- Resistance to shock and vibration
- Integral flange option features built-in lens
- Fit 'N Forget™ adapter plug provides corrosion and moisture resistance
- Integral flange option features built-in lens



Part Number	Lens Color	Lamp Connector	Plug Side 1	Plug Side 2	Volts	Amps	Metalized	Warning Class
60360R	Red	Fit 'N Forget S.S.	No Plug	No Plug	12	0.5	no	II
60360Y	Yellow	Fit 'N Forget S.S.	No Plug	No Plug	12	0.5	no	II
60362R	Red	Fit 'N Forget S.S.	No Plug	No Plug	12	0.5	yes	II
60362Y	Yellow	Fit 'N Forget S.S.	No Plug	No Plug	12	0.5	yes	II

SUPER 60[®], LED, 36 DIODE, SELF-CONTAINED, GROMMET MOUNT, KIT

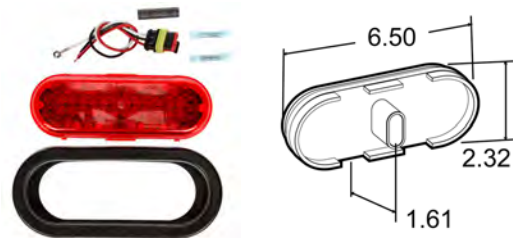

- External power pack not required
- Metalized reflector version offers more intense focused light
- Non-metalized version offers wider viewing angle
- Dual or quad flashing patterns
- Meets recommended SAE J1318 and J845 photometric specifications
- Synchronized alternating feature
- Lamp life rated at 100,000 hours
- Resistance to shock and vibration
- Fit 'N Forget™ adapter plug provides corrosion and moisture resistance
- Integral flange option features built-in lens



Part Number	Lens Color	Lamp Connector	Plug Side 1	Plug Side 2	Volts	Amps	Mount Color	Warning Class	Kit Includes
60122R	Red	Fit 'N Forget S.S.	Fit 'N Forget S.S.	Stripped End/Ring Terminal	12	0.5	Red	II	60360r, 60700 grommet, 95220 plug
60122Y	Yellow	Fit 'N Forget S.S.	Fit 'N Forget S.S.	Stripped End/Ring Terminal	12	0.5	Black	II	60360y lens, 60700 grommet, 95220 plug

SUPER 60[®], LED, 36 DIODE, SELF-CONTAINED, METALIZED GROMMET MOUNT, KIT



- External power pack not required
- Metalized reflector version offers more intense focused light
- Non-metalized version offers wider viewing angle
- Dual or quad flashing patterns
- Meets recommended SAE J1318 and J845 photometric specifications
- Mounts horizontally or vertically
- Lamp life rated at 100,000 hours
- Resistance to shock and vibration
- Integral flange option features built-in lens
- Fit 'N Forget™ adapter plug provides corrosion and moisture resistance
- Integral flange option features built-in lens



Part Number	Lens Color	Lamp Connector	Plug Side 1	Plug Side 2	Volts	Amps	Mount Color	Warning Class	Kit Includes
60120R	Red	Fit 'N Forget S.S.	Fit 'N Forget S.S.	Stripped End/Ring Terminal	12	0.5	Red	II	60362r lens, 60700 grommet, 95220 plug
60120Y	Yellow	Fit 'N Forget S.S.	Fit 'N Forget S.S.	Stripped End/Ring Terminal	12	0.5	Black	II	60362r lens, 60700 grommet, 95220 plug

SUPER 60[®], LED, 36 DIODE, SELF CONTAINED, FLANGE MOUNT



- External power pack not required
- Metalized reflector version offers more intense focused light
- Non-metalized version offers wider viewing angle
- Dual or quad flashing patterns
- Meets recommended SAE J1318 and J845 photometric specifications
- Mounts horizontally or vertically
- Lamp life rated at 100,000 hours
- Resistance to shock and vibration
- Integral flange option features built-in lens
- Fit 'N Forget™ adapter plug provides corrosion and moisture resistance
- Integral flange option features built-in lens

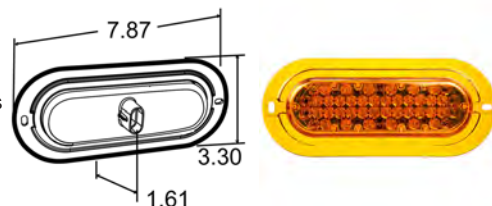

Part Number	Lens Color	Lamp Connector	Plug Side 1	Plug Side 2	Volts	Amps	Mount Color	Warning Class
60366R	Red	Fit 'N Forget S.S.	No Plug	No Plug	12	0.5	Red	II
60366Y	Yellow	Fit 'N Forget S.S.	No Plug	No Plug	12	0.5	Black	II

SUPER 60[®], LED, 36 DIODE, SELF CONTAINED, METALIZED, FLANGE MOUNT



- External power pack not required
- Metalized reflector version offers more intense focused light
- Non-metalized version offers wider viewing angle
- Dual or quad flashing patterns
- Meets recommended SAE J1318 and J845 photometric specifications
- Mounts horizontally or vertically
- Lamp life rated at 100,000 hours
- Resistance to shock and vibration
- Integral flange option features built-in lens
- Fit 'N Forget™ adapter plug provides corrosion and moisture resistance
- Integral flange option features built-in lens

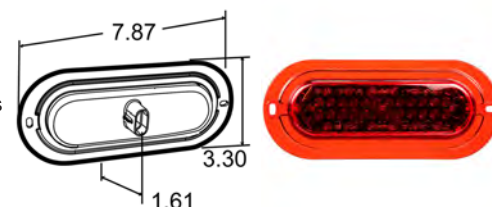

Part Number	Lens Color	Lamp Connector	Plug Side 1	Plug Side 2	Volts	Amps	Mount Color	Warning Class
60364R	Red	Fit 'N Forget S.S.	No Plug	No Plug	12	0.5	Red	II
60364Y	Yellow	Fit 'N Forget S.S.	No Plug	No Plug	12	0.5	Black	II

SUPER 60[®], LED, 36 DIODE, SELF-CONTAINED, FLANGE MOUNT, KIT

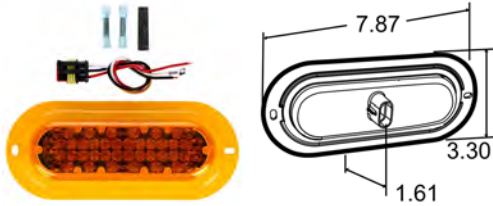

- External power pack not required
- Metalized reflector version offers more intense focused light
- Non-metalized version offers wider viewing angle
- Dual or quad flashing patterns
- Meets recommended SAE J1318 and J845 photometric specifications
- Mounts horizontally or vertically
- Lamp life rated at 100,000 hours
- Resistance to shock and vibration
- Integral flange option features built-in lens
- Fit 'N Forget™ adapter plug provides corrosion and moisture resistance
- Integral flange option features built-in lens



Part Number	Lens Color	Lamp Connector	Plug Side 1	Plug Side 2	Volts	Amps	Mount Color	Warning Class	Kit Includes
60126R	Red	Fit 'N Forget S.S.	Fit 'N Forget S.S.	Stripped End/Ring Terminal	12	0.5	Red	II	60366r lens, 95220 plug
60126Y	Yellow	Fit 'N Forget S.S.	Fit 'N Forget S.S.	Stripped End/Ring Terminal	12	0.5	Yellow	II	60366y lens, 95220 plug

SUPER 60[®], LED, 36 DIODE, SELF-CONTAINED, METALIZED FLANGE MOUNT, KIT

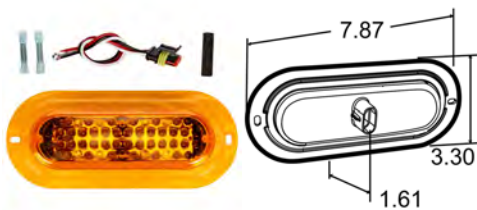

- External power pack not required
- Metalized reflector version offers more intense focused light
- Non-metalized version offers wider viewing angle
- Dual or quad flashing patterns
- Meets recommended SAE J1318 and J845 photometric specifications
- Mounts horizontally or vertically
- Lamp life rated at 100,000 hours
- Resistance to shock and vibration
- Integral flange option features built-in lens
- Fit 'N Forget™ adapter plug provides corrosion and moisture resistance
- Integral flange option features built-in lens



Part Number	Lens Color	Lamp Connector	Plug Side 1	Plug Side 2	Volts	Amps	Mount Color	Warning Class	Kit Includes
60124R	Red	Fit 'N Forget S.S.	Fit 'N Forget S.S.	Stripped End/Ring Terminal	12	0.5	Red	II	60364r lens, 95220 plug
60124Y	Yellow	Fit 'N Forget S.S.	Fit 'N Forget S.S.	Stripped End/Ring Terminal	12	0.5	Black	II	60364y lens, 95220 plug

LED, 4 DIODE, 1", SELF CONTAINED, FLANGE MOUNT



- 25 selectable flash patterns
- Changeable colored lenses: yellow, blue and red
- Spherical LED heads are designed with diffusing optics for extremely wide-angle light output

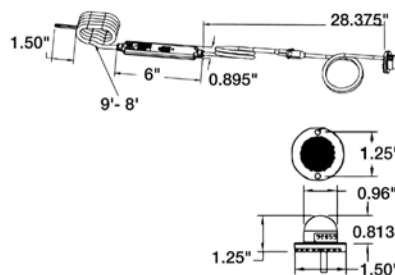

Part Number	Lens Color	Lamp Connector	Plug Side 1	Plug Side 2	Volts	Amps	Mount Color
92855	Clear	Hardwired	Hardwired	Stripped End	12 24	0.15	Silver

LED, 16 DIODE, SELF CONTAINED, 2 SCREW



- Designed for excellent versatile perimeter lighting
- Directional warning for any type of vehicle including trash, D.O.T., wreckers and utility vehicles
- Features five selectable flash pattern per light head
- Meets SAE J1318 Class II, J845 Class 2, J595 40-degree angle when properly configured
- Potted circuitry and waterproof power supply
- Very bright signal in compact design
- Low amp draw, dual 12V or 24V
- Easy installation

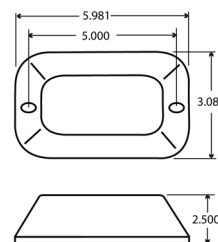

Part Number	Lens Color	Lamp Connector	Plug Side 1	Plug Side 2	Volts	Amps	Mount Color	Warning Class
92695Y	Yellow	Hardwired	Hardwired	Blade Terminal/ Stripped End Ring Terminal	12	0.2	Silver	II

LED, 16 DIODE, SELF CONTAINED, 2 SCREW, KIT



- Designed for excellent versatile perimeter lighting
- Directional warning for any type of vehicle including trash, D.O.T., wreckers and utility vehicles
- Features five selectable flash pattern per light head
- Meets SAE J1318 Class II, J845 Class 2, J595 40-degree angle when properly configured
- Potted circuitry and waterproof power supply
- Very bright signal in compact design
- Low amp draw, dual 12V or 24V
- Easy installation

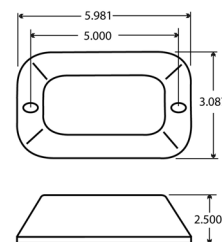

Part Number	Lens Color	Lamp Connector	Plug Side 1	Plug Side 2	Volts	Amps	Mount Color	Warning Class
92696Y	Yellow	Hardwired	Hardwired	Blade Terminal/ Stripped End Ring Terminal	12	0.2	Black	II

LED

18 DIODE

LED, 18 DIODE, 1.5"X5", SELF CONTAINED, SURFACE MOUNT, KIT

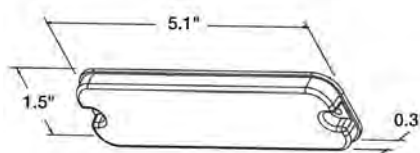

- 16 flash patterns including random
- 18 high-intensity LEDs
- Encapsulated electronics extend product life
- Synchronization capable



Part Number	Lens Color	Lamp Connector	Plug Side 1	Plug Side 2	Volts	Amps	Mount Color	Warning Class
92872R	Clear Red	Hardwired	Hardwired	Stripped End	12	0.5	Clear	I
92872Y	Clear Yellow	Hardwired	Hardwired	Stripped End	12	0.5	Clear	I
92872B	Clear Blue	Hardwired	Hardwired	Stripped End	12	0.5	Clear	I
92872C	Clear Clear	Hardwired	Hardwired	Stripped End	12	0.5	Clear	I

LED

18 DIODE

LED, 18 DIODE, 4"X2", SELF CONTAINED, SURFACE MOUNT, KIT

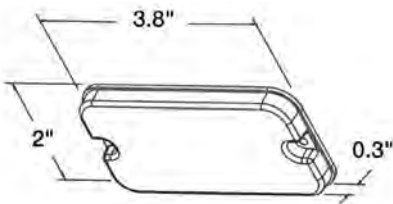

- 16 flash patterns including random
- 18 high-intensity LEDs
- Encapsulated electronics extend product life
- Synchronization capable



Part Number	Lens Color	Lamp Connector	Plug Side 1	Plug Side 2	Volts	Amps	Mount Color	Warning Class
92871R	Clear Red	Hardwired	Hardwired	Stripped End	12	0.5	Clear	I
92871Y	Clear Yellow	Hardwired	Hardwired	Stripped End	12	0.5	Clear	I
92871B	Clear Blue	Hardwired	Hardwired	Stripped End	12	0.5	Clear	I
92871C	Clear	Hardwired	Hardwired	Stripped End	12	0.5	Clear	I

LED, 56 DIODE, 2"X6", SELF CONTAINED, SURFACE MOUNT



- 15 flash patterns including random
- 56 high-intensity LEDs
- Extremely thin design

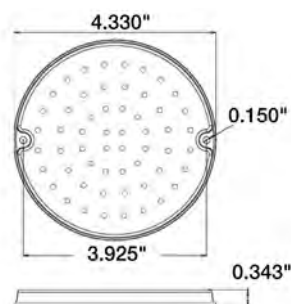

Part Number	Lens Color	Lamp Connector	Plug Side 1	Plug Side 2	Volts	Amps	Mount Color	Warning Class
92876R	Clear Red	Hardwired	Hardwired	Stripped End	12	0.8	Clear	I
92876Y	Clear Yellow	Hardwired	Hardwired	Stripped End	12	0.8	Clear	I

LED, 56 DIODE, 2"X6", SELF CONTAINED, SURFACE MOUNT, KIT



- LED retrofit kit for front-loader waste haulers
- Features 2 LED Model 60 front, park and turn lamps and 4 LED Super 44 turn signal lamps

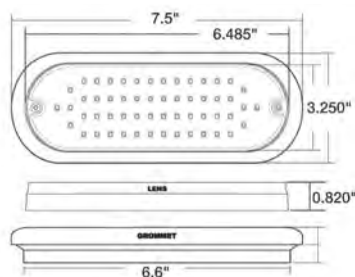

Part Number	Lens Color	Lamp Connector	Plug Side 1	Plug Side 2	Volts	Amps	Mount Color	Warning Class
92873R	Clear Red	Hardwired	Hardwired	Stripped End	12	0.8	Black	I
92873Y	Clear Yellow	Hardwired	Hardwired	Stripped End	12	0.8	Black	I

LED, 56 DIODE, 4", SELF CONTAINED, SURFACE MOUNT

LED

56 DIODE

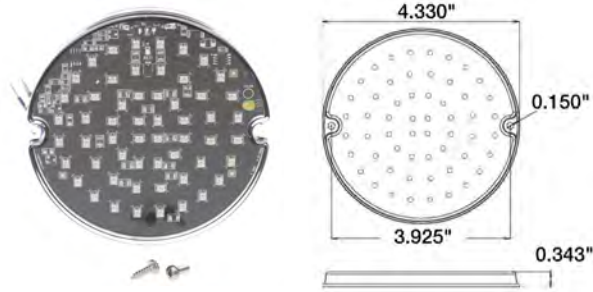

- 15 flash patterns including random
- 56 high-intensity LEDs
- Extremely thin design



Part Number	Lens Color	Lamp Connector	Plug Side 1	Plug Side 2	Volts	Amps	Mount Color	Warning Class
92876R	Clear Red	Hardwired	Hardwired	Stripped End	12	0.8	Clear	I
92876Y	Clear Yellow	Hardwired	Hardwired	Stripped End	12	0.8	Clear	I

LED, 56 DIODE, 4", SELF CONTAINED, GROMMET MOUNT, KIT

LED

56 DIODE

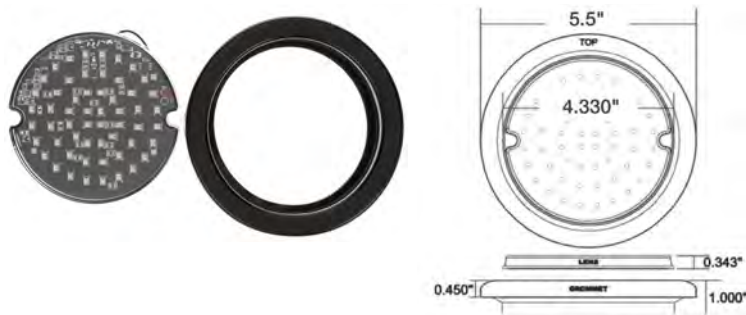

- 15 flash patterns including random
- 56 high-intensity LEDs
- Extremely thin design



Part Number	Lens Color	Lamp Connector	Plug Side 1	Plug Side 2	Volts	Amps	Mount Color	Warning Class
92874R	Clear Red	Hardwired	Hardwired	Stripped End	12	0.8	Black	I
92874Y	Clear Yellow	Hardwired	Hardwired	Stripped End	12	0.8	Black	I

STROBE TUBE, INCANDESCENT, 1 BULB, 1", SELF-CONTAINED, FLANGE MOUNT

STROBE TUBE



- Smallest plug-in style strobe head assembly available
- Brighter and more effective than "wig-wag" halogen flashing lights
- Increases vehicle conspicuity to reduce accident rate (check local legal requirements and restrictions)
- Upgrades existing incandescent rear entry (composite) signal lamps
- Hideaway concept ideal for many types of vehicles found in fleets such as police, fire, ambulance, wrecker and municipal - where increased visibility is emphasized
- Simple installation: proper space must be available in existing composite lamp assembly for maximum reliability and intensity



Part Number	Lens Color	Lamp Connector	Plug Side 1	Plug Side 2	Volts	Amps	Mount Color
92846	Clear	Hardwired	Hardwired	3 Pin Connector	12 24	0.5	Black

STROBE TUBE, INCANDESCENT, 1 BULB, 2"X5", REMOTED, FIX ANGLE BRACKET MOUNT



- Rugged polycarbonate lens and housing are sealed
- Foam gasket provides additional seal between the vehicle body and the lamp
- Includes weather-tight connectors
- Contains one flash tube rated for over five million flashes
- Surface mounts to the side, roof or rear of vehicle on two holes at 4.81" centers
- Provides 270 degrees of strobe warning light
- Upgraded from Packard to Deutsch connector, use #94236 adapter

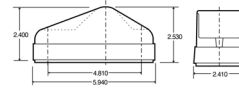

Part Number	Lens Color	Lamp Connector	Plug Side 1	Plug Side 2	Volts	Amps	Mount Color	Warning Class
92556Y	Yellow	Hardwired	Hardwired	3 Pin Weather tight Connector	12 24	2	Black	I

STROBE TUBE, INCANDESCENT, 1 BULB, 2"X6", REMOTED GROMMET MOUNT, KIT



- Rugged polycarbonate lens and housing are welded
- Uses standard mounting accessories
- Includes mounting grommet and weather-tight connectors
- Contains one flash tube rate for over five million flashes
- Lamp flush mounts
- Upgraded from Packard to Deutsch connector, use #94236 adapter

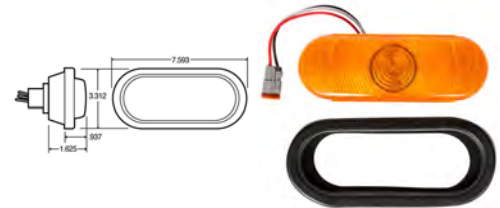

Part Number	Lens Color	Lamp Connector	Plug Side 1	Plug Side 2	Volts	Amps	Mount Color	Warning Class
92551Y	Yellow	Hardwired	Hardwired	3 Pin Weather tight Connector	12 24	2	Black	I

STROBE TUBE, INCANDESCENT, 1 BULB, 3"X5", REMOTED GROMMET MOUNT, KIT



- Rugged polycarbonate lens and housing are sealed
- Uses standard mounting accessories
- Includes mounting grommet and weather-tight connectors
- Contains one flash tube rate for over five million flashes
- Ideal for use on LLV Postal vehicles
- Lamp flush mounts

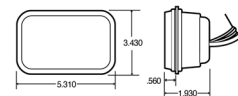

Part Number	Lens Color	Lamp Connector	Plug Side 1	Plug Side 2	Volts	Amps	Mount Color
92557Y	Yellow	Hardwired PL-2	Hard-wired PL-2	3 Pin Weather tight Connector	12 24	2	Black

STROBE TUBE

STROBE TUBE, INCANDESCENT, 1 BULB, 4", REMOTED, GROMMET MOUNT, KIT

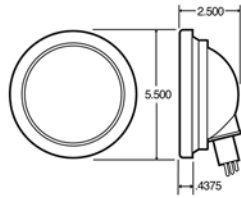

- Rugged polycarbonate lens and housing are sealed
- Uses standard mounting accessories
- Includes mounting grommet and weather-tight connectors
- Contains one flash tube rated for over five million flashes
- Lamp flush mounts
- Upgraded from Packard to Deutsch connector, use #94236 adapter



Part Number	Lens Color	Lamp Connector	Plug Side 1	Plug Side 2	Volts	Amps	Mount Color	Warning Class
92550Y	Yellow	Hardwired	Hardwired	3 Pin Weather tight Connector	12 24	2	Black	I

STROBE TUBE

STROBE TUBE, INCANDESCENT, 1 BULB, 4", REMOTED, 1 STUD MOUNT

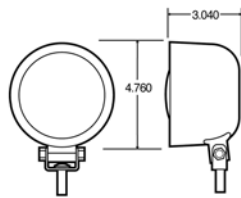

- Durable synthetic rubber housing resists corrosion
- Features high impact polycarbonate lens
- Mounts to the grill or rear of vehicle on one 5/16 -18 stud
- Features watertight connectors
- Contains one sealed-beam flash tube rated for over 5 million flashes
- Includes a universal mounting bracket
- Upgraded from Packard to Deutsch connector, use #94236 adapter



Part Number	Lens Color	Lamp Connector	Plug Side 1	Plug Side 2	Volts	Amps	Mount Color	Warning Class
92553Y	Yellow	Hardwired	Hardwired	3 Pin Weather tight Connector	12 24	2	Black	I
92555Y	Yellow	Hardwired	Hardwired	3 Pin Weather tight Connector	12 24	2	Black	I

STROBE TUBE

STROBE TUBE, INCANDESCENT, 1 BULB, 7", REMOTED, 4 SCREW

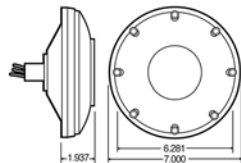

- Rugged polycarbonate lens and housing are sealed
- Includes weather tight-connectors
- Contains one flash tube rated for over five million flashes
- Surface mounts to the rear of vehicle by four holes on a 6.28" circle
- Upgraded from Packard to Deutsch connector, use #94236 adapter



Part Number	Lens Color	Lamp Connector	Plug Side 1	Plug Side 2	Volts	Amps	Warning Class
92552Y	Yellow	Hardwired	Hardwired	3 Pin Weather tight Connector	12 24	2	I

HIDEAWAY SYSTEM, STROBE TUBE, 2 BULB, INCANDESCENT, 1", REMOTED, FLANGE MOUNT, KIT



- Hideaway system ideal for many types of vehicles found in fleets such as police, ambulance, fire, wrecker and municipal
- Emphasizes increased light visibility
- Increases vehicle conspicuity to reduce accidental rates (check local legal requirements and restrictions)
- Upgrades existing incandescent rear entry signal lamps
- Includes 2 hideaway light heads, 25W remote power supply and 15' shielded cable
- 10 selectable flash patterns
- Requires 1" diameter cutout in signal lamp



Part Number	Lens Color	Lamp Connector	Plug Side 1	Plug Side 2	Volts	Amps	Mount Color	Kit Includes
92844	Clear	Hardwired	Hardwired	3 Pin Connector	12 24	6	Black	92846 bulb, 9944 plug

HIDEAWAY SYSTEM, STROBE TUBE, 4 BULB, INCANDESCENT, 1", REMOTED FLANGE MOUNT, KIT



- Hideaway system ideal for many types of vehicles found in fleets such as police, fire, ambulance, wrecker and municipal
- Emphasizes increased light visibility
- Increases vehicle conspicuity to reduce accidental rates (check local requirements and restrictions)
- Upgrades existing incandescent rear entry signal lamps
- 10 selectable flash patterns
- Requires 1" diameter cutout in signal lamp
- Includes 4 hideaway light heads, 60W remote power supply and 15' shielded cable



Part Number	Lens Color	Lamp Connector	Plug Side 1	Plug Side 2	Volts	Amps	Mount Color	Kit Includes
92845	Clear	Hardwired	Hardwired	3 Pin Connector	12 24	6	Black	92846 bulb, 6660ps supply, 9944 plug

LED

CLASS 1

LED, CLASS 1, HIGH PROFILE , PERMANENT MOUNT

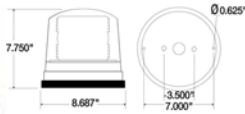

- Clear cover seals out dirt and can be cleaned easily
- 24 selectable flash patterns via internal jumper
- LED diagnostic indicator
- Modular circuit is completely encapsulated for increased shock & weather resistance
- Mounts easily with two toggle bolts on 3-1/2" centers



Part Number	Lens Color	Plug Side 2	Volts	Amps Major/Minor	Warning Class	Selectable Flash Patterns (Y/N)
92865Y	Yellow	Stripped End	12 24	0.41	I	Yes

LED

CLASS 1

LED, CLASS 1, MEDIUM PROFILE, PERMANENT MOUNT, PIPE MOUNT

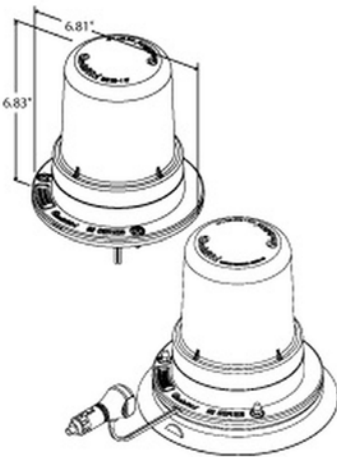

- Optics designed specifically for LED Technology, not as a gaseous discharge retrofit
- Additional color options excellent option for city/county municipal, cement mixer, and other heavy-duty, construction or off-road applications
- Dual and quad Class I flash patterns meet legal functions
- Rugged black powder coated corrosion-resistant die-cast aluminum base
- Designed for surface mount as well as pipe mount (1NPT pipe thread)
- Electronics and light source are fully encapsulated in epoxy to protect components from moisture damage and corrosives
- Protected against industry-standard electrical transient per SAE J1455
- Linear supply offers reduced EMI over that of gaseous discharge systems
- Threaded lens design does not require tool to replace lens
- Designed without external optics to reduce maintenance and cleaning
- Mounting gasket and #10 installation screws included
- Magnetic mount version features neodymium magnets, the strongest type of magnet, featuring up to 120 pounds of magnetic pull
- Magnetic mount includes rubber suction material for extra insurance, reducing any risk of separation of light from contact surface
- Cigarette plug features on/off switch with LED indicator light



Part Number	Lens Color	Plug Side 2	Volts	Amps Major/Minor	Warning Class	Selectable Flash Patterns (Y/N)
92565Y	Yellow	Stripped End	12	2.6	I	No
92566Y	Yellow Clear	Stripped End	12	2.6	I	No
92565R	Red	Stripped End	12	2.6	I	No
92565B	Blue	Stripped End	12	2.6	I	No
92565C	Clear	Stripped End	12	2.6	I	No
92568Y	Yellow	Stripped End	24	1.3	I	No
92568R	Red	Stripped End	24	1.3	I	No
92568B	Blue	Stripped End	24	1.3	I	No
92568C	Clear	Stripped End	24	1.3	I	No
92860Y	Yellow	Stripped End	12 24	0.3	I	No

LED, CLASS 1, MEDIUM PROFILE, PERMANENT MOUNT



- 24 selectable flash patterns via internal jumper
- LED diagnostic indicator
- Modular circuit is completely encapsulated for increased shock and weather resistance

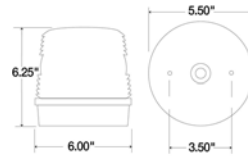

Part Number	Lens Color	Plug Side 2	Volts	Amps Major/Minor	Warning Class	Selectable Flash Patterns (Y/N)
92864Y	Yellow	Stripped End	12 24	0.41	I	Yes

LED, CLASS 1, LOW PROFILE, PERMANENT MOUNT, PIPE MOUNT



- Meets Class I output requirements.
- Optics designed specifically for LED technology, not as a gaseous discharge retrofit
- Dual and quad flash patterns meet legal functions
- Rugged black powder coated corrosion-resistant die-cast aluminum base
- Designed for surface mount as well as pipe mount (1" NPT pipe thread)
- Electronics and light source are fully encapsulated in epoxy
- Protected against industry-standard electrical transient per SAE J1455
- Linear supply offers reduced EMI over that of gaseous discharge systems
- Threaded-lens design does not require tool to replace lens
- Designed without external optics to reduce maintenance and cleaning
- Mounting gasket and #10 installation screws included

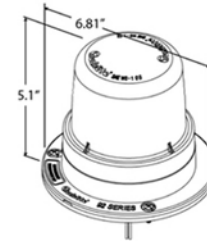

Part Number	Lens Color	Plug Side 2	Volts	Amps Major/Minor	Warning Class	Selectable Flash Patterns (Y/N)
92564C	Clear	Stripped End	12	2.2	I	No
92564Y	Yellow	Stripped End	12	2.2	I	No

LED, CLASS 2, LOW PROFILE, PERMANENT MOUNT

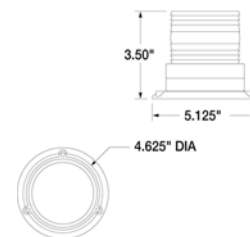

Part Number	Lens Color	Plug Side 2	Volts	Amps Major/Minor	Warning Class	Selectable Flash Patterns (Y/N)
307A	Yellow	Stripped End	12 24 36 48	0.5	III	No
300A	Yellow	Stripped End	12	0.35	III	Yes

LED, CLASS 2, LOW PROFILE, PERMANENT MOUNT, PIPE MOUNT

LED

CLASS 2

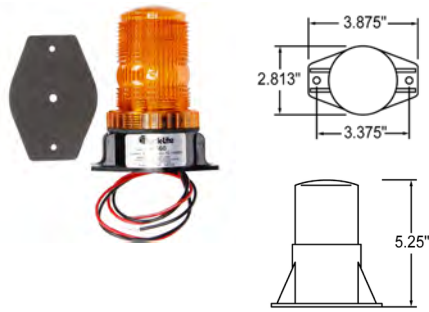

- Ideal for material handling market
- Recognized under the Component Program of Underwriters Laboratories, Inc. for battery-powered industrial truck accessory
- Flash rate and intensity: 85 FPM, 1.5Joule/175,000 CP (strobe)
- Only 0.5 amp at 12 VDC, 0.25 amp at 24 VDC (strobe) .35V (LED)
- 12-110V (strobe) 10-16V (LED)
- 29 selectable flash patterns
- Fully encapsulated LED circuitry ensures trouble-free operation
- Polycarbonate base and domes provide excellent durability
- Review installation instructions and warning labels for proper use



Part Number	Lens Color	Plug Side 2	Volts	Amps Major/Minor	Warning Class	Selectable Flash Patterns (Y/N)
92534Y	Yellow	Stripped End	12	0.5	III	No
92560	Yellow	Stripped End	12 24 36 48	0.55	III	No
92563	Yellow	Stripped End	12	0.35	III	Yes
92862Y	Yellow	Stripped End	12 24	0.3	II	No

LED, CLASS 2, LOW PROFILE, MAGNETIC MOUNT

LED

CLASS 2



- Modular components and encapsulated circuitry make for quick repairs and minimize downtime
- Designed with solid-state electronics for long-term dependability
- Features reverse polarity protection
- Operates in temperature ranging from -20°F to 135°F
- Operates at 12v, .5 amp and uses 3.0 joules per flash
- Mounts with 1/2" conduit pipe and includes knockouts for permanent surface mounting
- Review installation instructions and warning labels for proper use



Part Number	Lens Color	Plug Side 2	Volts	Amps Major/Minor	Warning Class	Selectable Flash Patterns (Y/N)
313A	Yellow	Cigarette Adapter	12 24 36 48	0.5	III	No
92539Y	Yellow	Cigarette Adapter	12	0.5	III	No
301A	Yellow	Cigarette Adapter	12	0.35	III	Yes
92863Y	Yellow	Cigarette Adapter	12 24	0.3	II	No

HALOGEN, CLASS 1, PERMANENT MOUNT



- Rubbolite M153 series and approved rotating halogen beacons
- Magnetic mount with cigarette plug adapter
- 3-bolt mounting with 16 gauge wire

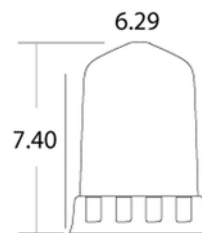

Part Number	Lens Color	Plug Side 2	Volts	Warning Class	Selectable Flash Patterns (Y/N)
6822A	Yellow	Blunt Cut	12	I	No

HALOGEN

CLASS 1

HALOGEN, CLASS 1, MAGNETIC MOUNT



- Rubbolite M153 series and approved rotating halogen beacons
- Magnetic mount with cigarette plug adapter
- 3-bolt mounting with 16 gauge wire

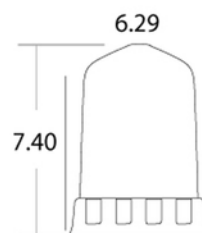

Part Number	Lens Color	Plug Side 2	Volts	Warning Class	Selectable Flash Patterns (Y/N)
6823A	Yellow	Cigarette Adapter	12	I	No

HALOGEN

CLASS 1

HALOGEN, CLASS 2, MAGNETIC MOUNT

- Truck-Lite has replaced revolving beacon 333/333A to an upgraded version, 92602R/92602Y
- Meets Class 1, SAE J845
- Improved rotating gear drive mechanism for quieter operation
- Improved dual magnetic mounting, less prone to scratch vehicle paint
- Rate RPM: 120 +/- 5/minute
- Temperature Range: -4° F to 122° F

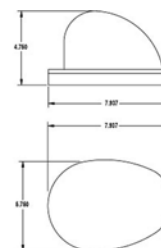

Part Number	Lens Color	Plug Side 2	Volts	Amps Major/Minor	Warning Class	Selectable Flash Patterns (Y/N)
92602B	Blue	Cigarette Adapter	12	3.5	II	No
92602Y	Yellow	Cigarette Adapter	12	3.5	II	No
92620Y	Yellow	Cigarette Adapter	12	1.7	II	No

HALOGEN

CLASS 2

GAS DISCHARGE

CLASS 1

GAS DISCHARGE, CLASS 1, HIGH PROFILE, PERMANENT MOUNT



- Double and quad flash versions operate at 12V or 24V, 2.0 amp and can be wired for high power (15 joules) or for low power (10 joules)
- Single-flash version operates at 12v, 1.8 and uses 8.0 joules per flash
- Clear cover seals out dirt and can be cleaned easily
- Modular components and encapsulated circuitry make for quick repairs
- Features reverse polarity protection
- Operates in temperatures from -20°F to +135°F
- Mounts easily with two toggle bolts at 3 1/2" centers
- Meets SAE J1318 Class 1-2-3 for double/quad flash or Class 2-3 for single flash
- Review installation instructions and warning labels for proper use



Part Number	Lens Color	Plug Side 2	Volts	Amps Major/Minor	Warning Class	Selectable Flash Patterns (Y/N)
92513Y	Yellow	Stripped End	12 24	2	I	Yes

GAS DISCHARGE

CLASS 1

GAS DISCHARGE, CLASS 1, MEDIUM PROFILE, PERMANENT MOUNT



- Quad flash, operates at 12V or 24V, 2.0 amp and can be wired for high power (15 joules) or for low power (10 joules)
- Modular components and encapsulated circuitry make for quick repairs
- Designed with solid state electronics for long-term dependability
- Features reverse polarity protection
- Operates in temperatures from -20°F to +135°F
- Mounts with 1/2" conduit pipe and includes knock-outs for permanent surface mounting
- Meets SAE J1318 Class 1-2-3 for quad flash
- Review installation instructions and warning labels for proper use

Part Number	Lens Color	Plug Side 2	Volts	Amps Major/Minor	Warning Class	Selectable Flash Patterns (Y/N)
92516Y	Yellow	Stripped End	12 24	2	I	Yes
92516C	Clear	Stripped End	12 24	2	I	Yes

GAS DISCHARGE, CLASS 1, MEDIUM PROFILE, PERMANENT MOUNT, PIPE MOUNT



- Multi-flash class 2 gas discharge strobe
- Field-selectable flash patterns via internal jumper single, double, quad flash
- Modular circuit is completely encapsulated for increased shock and weather resistance
- New design features twist on/off lens

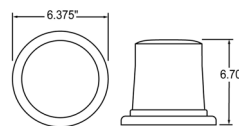

Part Number	Lens Color	Plug Side 2	Volts	Amps Major/Minor	Warning Class	Selectable Flash Patterns (Y/N)
6601A	Yellow	Stripped End	12	2	I	Yes
6811A	Yellow	Stripped End	12 24	2	I	Yes

GAS DISCHARGE

CLASS 1

GAS DISCHARGE, CLASS 1, MEDIUM PROFILE, MAGNETIC MOUNT



- Multi-flash class 2 gas discharge strobe
- Field-selectable flash patterns via internal jumper single, double, quad flash
- Modular circuit is completely encapsulated for increased shock and weather resistance
- New design features twist on/off lens

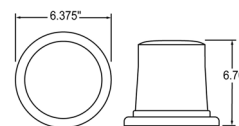

Part Number	Lens Color	Plug Side 2	Volts	Amps Major/Minor	Warning Class	Selectable Flash Patterns (Y/N)
6601MA	Yellow	Cigarette Adapter	12	2	I	Yes
6811MA	Yellow	Cigarette Adapter	12 24	2	I	Yes

GAS DISCHARGE

CLASS 1

GAS DISCHARGE, CLASS 1, LOW PROFILE, PERMANENT MOUNT



- Rugged polycarbonate and anodized, spun aluminum construction
- Includes 180" cable
- Contains one flash tube rated for over five million flashes
- Upgraded from Packard to Deutsch connector, use #94236 adapter

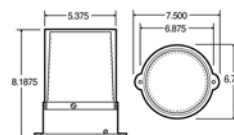

Part Number	Lens Color	Plug Side 2	Volts	Warning Class	Selectable Flash Patterns (Y/N)
92554Y	Yellow	3 Pin Weather tight Connector	12 24	I	No

GAS DISCHARGE

CLASS 1

GAS DISCHARGE, CLASS 1, LOW PROFILE, PERMANENT MOUNT



- Rugged polycarbonate and anodized, spun aluminum construction
- Includes 180" cable
- Contains one flash tube rated for over five million flashes
- Upgraded from Packard to Duetch connector, use #94236 adapter



Part Number	Lens Color	Plug Side 2	Volts	Amps Major/Minor	Warning Class	Selectable Flash Patterns (Y/N)
6600A	Yellow	Stripped End	12	2	I	Yes
6600B	Blue	Stripped End	12	2	I	Yes
6600W	Clear	Stripped End	12	2	I	Yes
6810A	Yellow	Stripped End	12 24	2	I	Yes

GAS DISCHARGE, CLASS 1, LOW PROFILE, MAGNETIC MOUNT



- Multi-flash Class 2 gas discharge strobe
- Field-selectable flash patterns via internal jumper single, double, quad flash
- Modular circuit is completely encapsulated for increased shock and weather resistance
- New design features twist on/off lens
- Electronics sealed in epoxy for increased weather and shock resistance



Part Number	Lens Color	Plug Side 2	Volts	Amps Major/Minor	Warning Class	Selectable Flash Patterns (Y/N)
6600MA	Yellow	Cigarette Adapter	12	2	I	Yes
6810MA	Yellow	Cigarette Adapter	12 24	2	I	Yes

Looking for even more product information?

Visit truck-lite.com



**Powerful Search
Function**



**360° Product
Images**



**Easy-To-Find
Replacement
Parts**

LED, 4" X 36", PERMANENT MOUNT

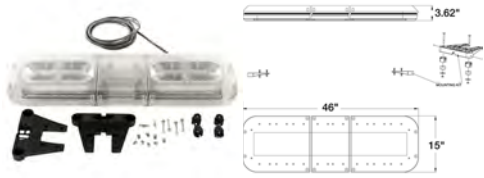

- 35 selectable flash patterns via external wire
- Adjustable lower level lights allow customizable positioning of light output
- Conformal coated circuitry protects against shock & vibration
- Dual-level, full-output light bar less than 4" tall
- High/low power select
- Independent enable of front and rear facing LEDs
- Low-input voltage detection under 10V DC



Part Number	Lens Color	Plug Side 2	Volts	Amps	Lens Material	Housing Material	Warning Class
92867Y	Clear / Yellow	Stripped End	12 24	4.6	PC	PC	I

LED, 5" X 19", PERMANENT MOUNT

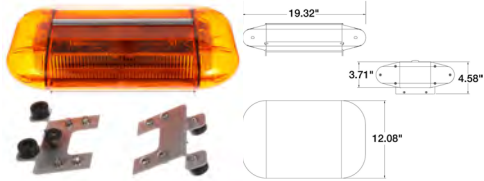

- Compact and quiet operation
- LED version features 20 selectable flash patterns via external pattern
- Select wire or internal jumper



Part Number	Lens Color	Plug Side 2	Volts	Amps	Lens Material	Housing Material	Warning Class
92866Y	Yellow	Stripped End	12 24	2	PC	Aluminum	I

LED, 5" X 47", PERMANENT MOUNT

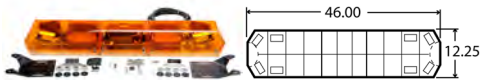

- Perfect for all warning applications, including tow trucks, construction, utility and D.O.T. vehicles
- Generates an incredibly bright, powerful signal with rich, true color
- Sleek appearance also produces less drag increasing fuel efficiency
- Powered through standard 12V input
- All voltage management handled at the light head
- Complies with SAE and California Title XIII when properly configured



Part Number	Lens Color	Plug Side 2	Volts	Amps	Lens Material	Housing Material	Warning Class
92590Y	Yellow	Blunt Cut	12	2	PC	Aluminum	I

INCANDESCENT, 5" X 46", PERMANENT MOUNT



- Features rear traffic director combined with standard light bars for maximum versatility
- Strobe version includes four 360° remote strobe heads, two double mirrors, two mirrors, one 4-head strobe pack, rear lower directional arrow assembly with colored lenses
- Halogen version includes two halogen rotators, two fast halogen rotators, three double mirrors, rear lower directional arrow assembly with colored lenses
- Review installation instructions and warning label for proper use

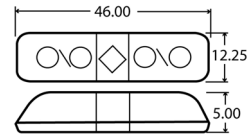

Part Number	Lens Color	Plug Side 2	Volts	Amps	Lens Material	Housing Material
92673Y	Yellow	Stripped End/Control Unit Connector	12	8.6	PC	PC

INCANDESCENT

LIGHT BAR

HALOGEN, 4.5" X 16", PERMANENT MOUNT



- Features two internal mirrors to enhance flashes
- Two halogen rotators
- Compact unit operates quietly
- Magnetic mount includes integral cigarette lighter adapter with 6' cord
- Flashes at a rate of 85 fpm while drawing 8.0 amp
- Review installation instructions and warning labels for proper use
- Plastic base resists corrosion

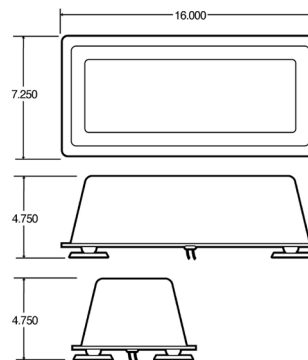

Part Number	Lens Color	Plug Side 2	Volts	Amps	Lens Material	Housing Material	Warning Class
92524Y	Yellow	Stripped End	12	8	PC	PC	I

HALOGEN

LIGHT BAR

HALOGEN, 4.5" X 16", MAGNETIC MOUNT



- Features two internal mirrors to enhance flashes
- Two halogen rotators
- Compact unit operates quietly
- Magnetic mount includes integral cigarette lighter adapter with 6' cord
- Flashes at a rate of 85 fpm while drawing 8.0 amp
- Review installation instructions and warning labels for proper use
- Plastic base resists corrosion

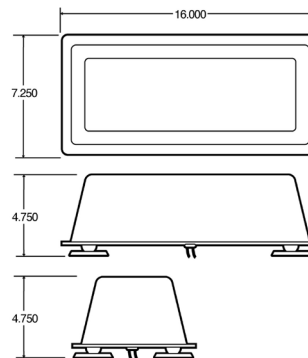

Part Number	Lens Color	Plug Side 2	Volts	Amps	Lens Material	Housing Material	Warning Class
92525B	Blue	Cigarette Adapter	12	8	PC	PC	I
92525Y	Yellow	Cigarette Adapter	12	8	PC	PC	I

HALOGEN

LIGHT BAR

HALOGEN

LIGHT BAR

HALOGEN, 5" X 36", PERMANENT MOUNT



- Halogen version includes two halogen rotators, two fast halogen rotators and two double mirrors
- Features two 360° strobe heads, one 2-head strobe, two double mirrors
- Linear strobe version features four 4.5" linear strobe heads, four 7" linear strobe heads, two 4 head strobe's
- Compact unit operates quietly
- 110 FPM, 2 amp draw
- Review installation instructions and warning labels for proper use



Part Number	Lens Color	Plug Side 2	Volts	Amps	Lens Material	Housing Material
92668Y	Yellow	Stripped End	12	16	PC	PC

HALOGEN

LIGHT BAR

HALOGEN, 5" X 46", PERMANENT MOUNT



- Halogen version includes two halogen rotators, two fast halogen rotators and two double mirrors
- Features two 360° strobe heads, one 2-head strobe, two double mirrors
- Linear strobe version features four 4.5" linear strobe heads, four 7" linear strobe heads, two 4 head strobe's
- Compact unit operates quietly
- 110 FPM, 2 amp draw
- Review installation instructions and warning labels for proper use



Part Number	Lens Color	Plug Side 2	Volts	Amps	Lens Material	Housing Material
92670Y	Yellow	Stripped End	12	16	PC	PC
92672Y	Yellow	Stripped End/Control Unit Connector	12	16	PC	PC

HALOGEN

LIGHT BAR

HALOGEN, 5" X 47", MAGNETIC MOUNT

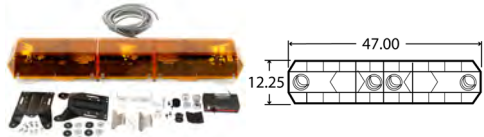

- Features dual decks for power and flexibility
- Extruded aluminum frame will not warp or bend
- Meets SAE J1318 Class I requirements
- Built-in rear traffic director
- H1 55W halogen rotating assemblies
- 18' harness exits on driver's side
- Dimensions: 5.75" H x 12.25" W



Part Number	Lens Color	Plug Side 2	Volts	Amps	Lens Material	Housing Material	Warning Class
92674Y	Yellow	Blunt Cut	12	4	PC	PC	I
92677Y	Yellow	Blunt Cut	12	8	PC	PC	I

GAS DISCHARGE, 4.5" X 16", PERMANENT MOUNT



- Features two internal mirrors to enhance flashes
- Available with two 15-joule strobe heads in double flash or quad flash versions
- Compact unit operates quietly
- Magnetic mount includes integral cigarette lighter adapter with 6' cord
- Flashes at a rate of 110 FPM while drawing 2.0 amp
- Review installation instructions and warning labels for proper use

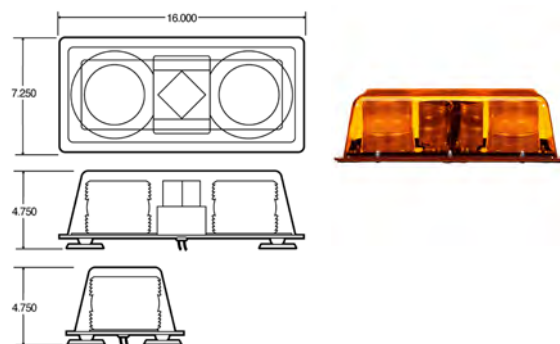

Part Number	Lens Color	Plug Side 2	Volts	Amps	Lens Material	Housing Material	Warning Class
92522Y	Yellow	Stripped End	12 24	2	PC	PC	II

GAS DISCHARGE

LIGHT BAR

GAS DISCHARGE, 4.5" X 16", MAGNETIC MOUNT



- Features two internal mirrors to enhance flashes
- Available with two 15-joule strobe heads in double flash or quad flash versions
- Compact unit operates quietly
- Magnetic mount includes integral cigarette lighter adapter with 6' cord
- Flashes at a rate of 110 FPM while drawing 2.0 amp
- Review installation instructions and warning labels for proper use

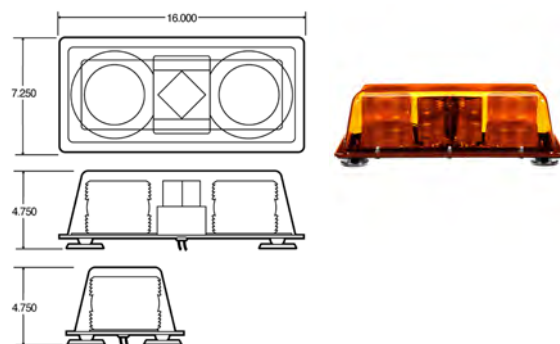

Part Number	Lens Color	Plug Side 2	Volts	Amps	Lens Material	Housing Material	Warning Class
92523Y	Yellow	Cigarette Adapter	12 24	2	PC	PC	II

GAS DISCHARGE

LIGHT BAR

GAS DISCHARGE, 5" X 36", PERMANENT MOUNT



- Halogen version includes two halogen rotators, two fast halogen rotators and two double mirrors
- Features two 360° strobe heads, one 2-head strobe, two double mirrors
- Linear strobe version features four 4.5" linear strobe heads, four 7" linear strobe heads, two 4 head strobe's
- Compact unit operates quietly
- 110 FPM, 2 amp draw
- Review installation instructions and warning labels for proper use



Part Number	Lens Color	Plug Side 2	Volts	Amps	Lens Material	Housing Material
92669Y	Yellow	Stripped End	12	2	PC	PC
92671Y	Yellow	Stripped End	12	8.6	PC	PC

GAS DISCHARGE

LIGHT BAR

LED

LED, TRAFFIC CONTROL LIGHT BAR MODULE

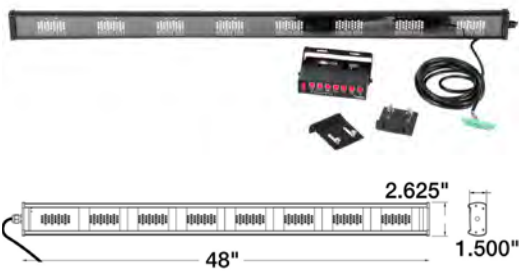

- Sealed design provides extreme weather resistance
- Control unit is operated with a combined circuit
- Highly efficient LED optics
- Control unit is micro-processor controlled with tactile front
- Heavy duty housing is resistant to warping, bending and/or corroding



Part Number	Lens Color	Plug Side 2	Volts	Amps	Lens Material	Housing Material
92868Y	Clear Yellow	Control Unit Connector	12	2.1	PC	Aluminum

LED

SIGNAL-STAT, LED, TRAFFIC ADVISOR W/CONTROL HEAD

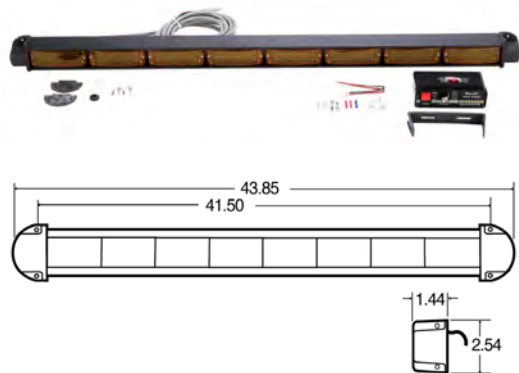

- Perfect for mounting to a utility body, the rear of a light bar, or as a stand alone rear deck unit
- Lightweight aluminum housing
- LED model features low-profile surface mount which installs easily with just four screws
- Includes mounting hardware, control head, 15' cable and connectors
- LED model offers long life (LEDs rated for 100,000 hours) and low current draw (.5 amp per lamp)
- Control head features four operating modes and eight programmable patterns with LED display of pattern in operation



Part Number	Lens Color	Plug Side 2	Volts	Amps	Lens Material	Housing Material
19680A	Yellow	Stripped End	12	0.5	PC	Aluminum

HALOGEN, ROTATOR TRAFFIC BAR



- Features compact design with dual decks
- Extruded aluminum frame will not warp or bend
- Meets SAE J1318 Class I requirements
- Built-in rear traffic director
- H1 55W halogen rotating assemblies
- Two diamond mirrors
- Dimensions: 4.5" H x 12.25" W x 47" L

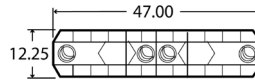

Part Number	Lens Color	Plug Side 2	Volts	Amps	Lens Material	Housing Material	Warning Class
92676Y	Yellow	Blunt Cut	12	1.5	Polycarbonate	Polycarbonate	I

HALOGEN

HALOGEN, ROTATOR LIGHT BAR



- Extruded aluminum base will not warp or bend
- Efficient parabola reflector provides excellent light dispersion and intensity
- 3-year manufacturer's motor assembly warranty
- Includes 15' shielded cable and detailed instructions
- Dimensions: 5.125" H x 6.3125" W x 47" L

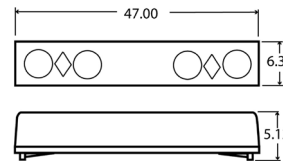

Part Number	Lens Color	Plug Side 2	Volts	Amps	Lens Material	Housing Material
92685Y	Yellow	Stripped End	12	6	Polycarbonate	Polycarbonate

HALOGEN

CONTROL BOX, TRAFFIC CONTROL BOX

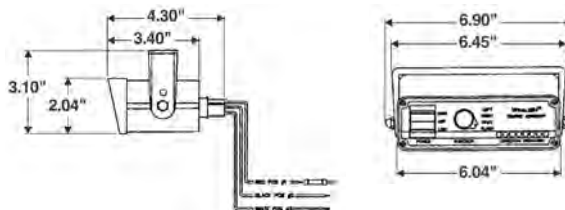

92849

Part Number	Volts	Amps	Plug Side 2	Housing Material
92760			Control Unit Connector	Steel
92849	12	5	Control Unit Connector	Steel



92760

TRAFFIC CONTROL BOX